

Features

- Two lever handles offer separate control of hot and cold water
- 5-15/16" (151 mm) spout reach
- 0.5 gpm (1.9 lpm) maximum flow rate at 60 psi (4.14 bar)
- KOHLER ceramic disc valves exceed industry longevity standards for a lifetime of durable performance
- Clicker drain with tailpiece and overflow
- Coordinates with other products in the Tone collection

Material

- Premium material construction for durability and reliability
- KOHLER finishes resist corrosion and tarnishing

Installation

- For 4" (102 mm) centers
- Deck-mount
- Handles are preassembled on valves to simplify installation

Water Conservation & Rebates

- This product can help a building earn Water Efficiency points in LEED™ Green Building Rating System

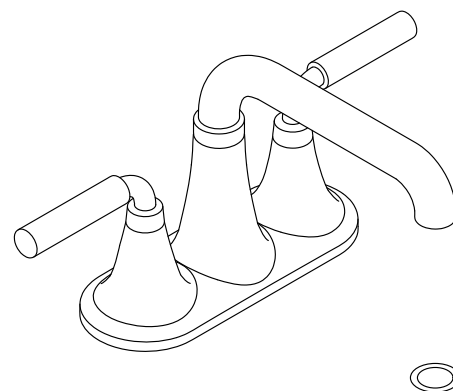

ADA
CSA B651
OBC

Codes/Standards







ASME A112.18.1/CSA B125.1
 NSF/ANSI/CAN 61
 NSF/ANSI/CAN 372
 All applicable US Federal and State material regulations
 DOE - Energy Policy Act 1992
 California Energy Commission (CEC)
 ADA
 ICC/ANSI A117.1
 CSA B651
 OBC

KOHLER® Faucet Lifetime Limited Warranty

See website for detailed warranty information.

Available Colors/Finishes

Color tiles intended for reference only.

Color	Code	Description
	CP	Polished Chrome
	BN	Vibrant™ Brushed Nickel
	BL	Matte Black
	2MB	Vibrant™ Brushed Moderne Brass
	CBL	Matte Black with Polished Chrome
	BMB	Matte Black with Moderne Brass

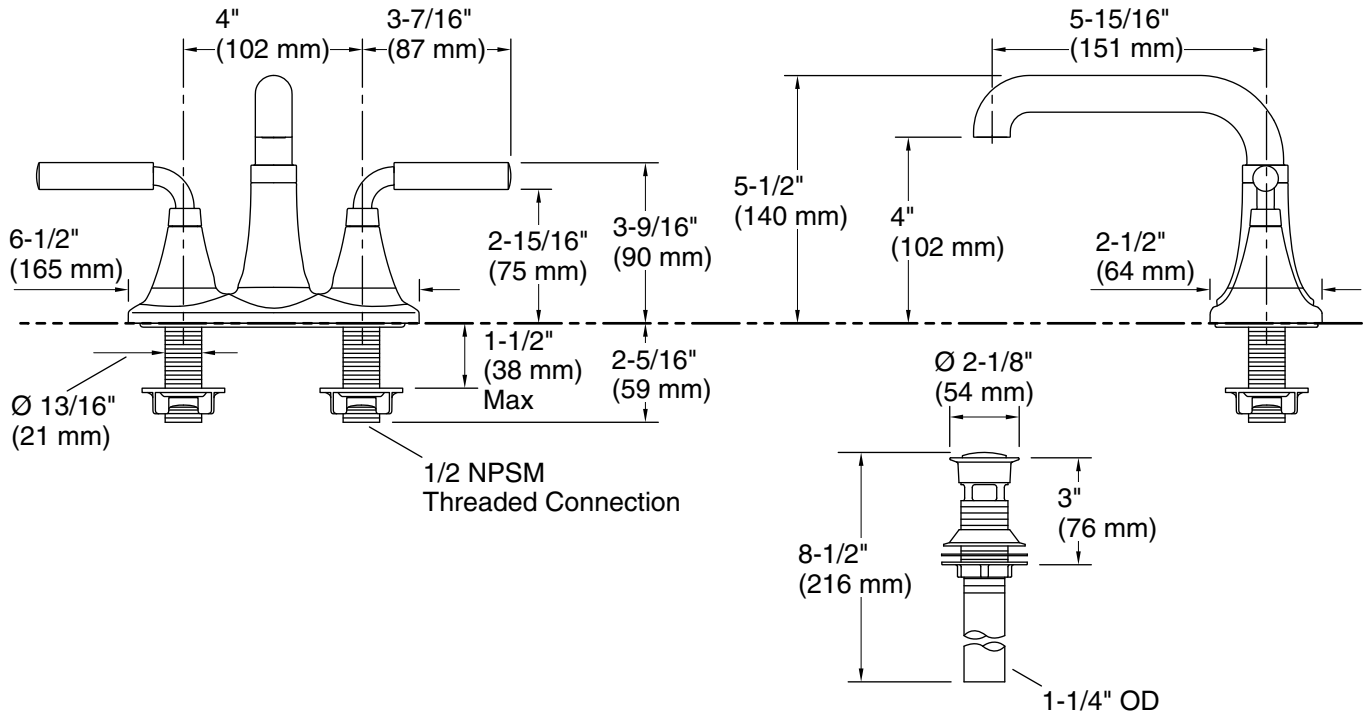

Technical Information

All product dimensions are nominal.

Faucet:

Flow rate: 0.5 gal/min (1.9 l/min)
 Pressure: 60 psi (4.1 bar)
 Drain included: Yes

Notes

Install this product according to the installation instructions.

ADA, OBC, CSA B651 compliant when installed to the specific requirements of these regulations.